



7.3 cu. ft. Rear Control Top Load Dryer

- 7.3 cu. ft. Ultra Large Capacity
- EasyLoad™ Door
- 8 Cycles / 12 Options
- Sensor Dry System
- Wrinkle Care Option
- FlowSense™ Duct Clogging & Lint Filter Indicators
- LoDecibel™ Quiet Operation
- LG ThinQ® Technology (Wi-Fi)



COLOR AVAILABILITY

- DLE7400VE (Electric) – Graphite Steel
- DLG7401VE (Gas) – Graphite Steel
- DLE7400WE (Electric) – White
- DLG7401WE (Gas) – White

CAPACITY & MATCHING WASHER

Capacity (cu. ft.)	7.3
Matching Washer	WT7405CW, WT7405CV, WT7400CW, WT7400CV

APPEARANCE

Electronic Controls with LED Display	Yes
Touch Buttons	Yes
Dial-A-Cycle™	Yes

DRYER CYCLES

Number of Cycles	8
Sensor Dry Cycles	Normal, Heavy Duty, Bedding, Delicates, Perm Press
Manual Dry Cycles	Speed Dry, Air Dry, Downloaded

DRYER OPTIONS

Number of Options	12
Options	Wrinkle Care, Custom Program, PGM Save, Child Lock, More Time, Less Time, Signal, Damp Dry Signal, Energy Saver, Default On / Off, Wi-Fi Connect, Remote Start
Temperature Settings	High, Med. High, Medium, Low, Ultra Low
Drying Levels	Very Dry, More Dry, Normal Dry, Less Dry, Damp Dry
Manual Dry Times	60 min., 50 min., 40 min., 30 min., 20 min., More Time / Less Time

FABRIC CARE

Sensor Dry	Yes
Precise Temperature Control with Variable Heater	Yes
Wrinkle Care Option	Yes
Steam Technology	No

CONVENIENCE

EasyLoad™ Door	Yes
LoDecibel™ Quiet Operation	Yes
Drum Light	Yes
Child Lock	Yes
FlowSense™ Duct Clogging Indicator	Yes
End of Cycle Signal	Yes
Remaining Time Display / Status Indicator(s)	Yes
Reversible Door	Yes
Venting Option	Electric: 4 Way Venting Gas: 3 Way Venting
3 Minute Installation Check	Yes
Leveling Legs	4 Adjustable Legs
ADA Compliant	No

SMART FEATURES

Wi-Fi Enabled	Yes
ThinQ®	Yes
Proactive Customer Care	Yes
Voice Control	Google Assistant, Amazon Alexa
SmartDiagnosis™	Yes
Remote Start (On / Off)	Yes
Remote Monitoring & Notifications	Yes

MATERIALS AND FINISHES

Drum Material	Aluminized Alloy Steel
Door / Trim	Solid / Silver Painted

TECHNICAL SPECS

Electrical Requirements	Electric: 240V, 30 Amps Gas: 120V, 15 Amps
Gas Dryer BTU Rating	20,000 Feet
Power Outlet Location	Within 48" of Either Side
Plug Type	Gas: 3-Prong (Cord Included) Electric: 4-Wire (Cord Required)
ENERGY STAR® Qualified	Yes
Combined Energy Factor (CEF)	Electric: 3.94 / Gas: 3.49

OPTIONAL ACCESSORIES

Drying Rack	3750EL0001C
LP Conversion Kit	383EEL3002D
Side Vent Kit	383EEL9001B

DIMENSIONS

Product (W x H x D)	27" x 44 1/4" x 29 1/2"
Depth with Door Open	50 1/4"
Cutout Dimensions (W x H x D)	29" x 45 1/4" x 34 1/2" (31 1/2" D for Side or Bottom Venting)
Carton Dimensions (W x H x D)	29 1/2" x 47 1/8" x 30 7/8"
Approx. Weight (Product / Carton)	Electric: 129.8 lbs. / 149.6 lbs. Gas: 132.5 lbs. / 152.3 lbs.

LIMITED WARRANTY

Parts and Labor	1 Year
Dryer Drum	3 Years (Parts Only)

DIMENSIONS / CLEARANCES

CLEARANCES FOR RECESSED AREA OR CLOSET INSTALLATION

The following spacing dimensions are recommended for this dryer. This dryer has been tested for clearances of 1 inch (2.5 cm) on the sides and rear. Recommended clearances should be considered for the following reasons:

- Additional clearances should be considered for ease of installation and servicing.
- Additional clearances might be required for wall, door and floor moldings.
- Additional clearances should be considered on all sides of the dryer to reduce noise transfer. For closet installation, with a door, minimum ventilation openings in the top and bottom of the door are required. Louvered doors with equivalent ventilation openings are acceptable.
- Companion appliance spacing should also be considered.

Closet Ventilation Requirements

Closets with doors must have both an upper and lower vent to prevent heat and moisture buildup in the closet. One upper vent opening with a minimum opening of 48 sq. in. (310 cm²) must be installed no lower than 6 feet above the floor. One lower vent opening with a minimum opening of 24 sq. in. (155 cm²) must be installed no more than one foot above the floor. Install vent grills in the door or cut down the door at the top and bottom to form openings. Louvered doors with equivalent ventilation openings are also acceptable.

INSTALLATION SPACING FOR RECESSED AREA OR CLOSET

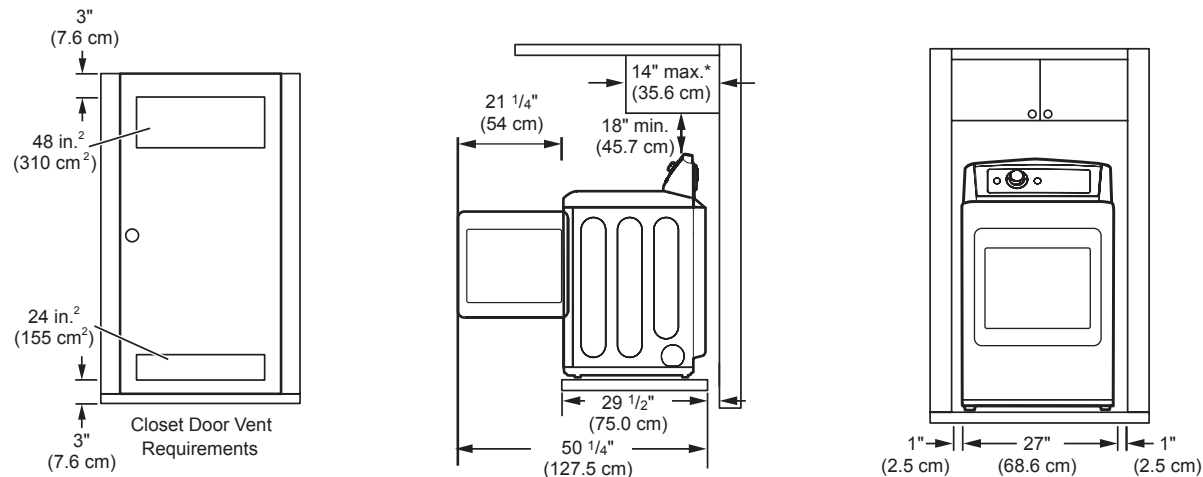

* Required spacing

DIMENSIONS / CLEARANCES

INSTALLATION SPACING FOR CABINET

For cabinet installation with a door, minimum ventilation openings in the top of the cabinet are required.

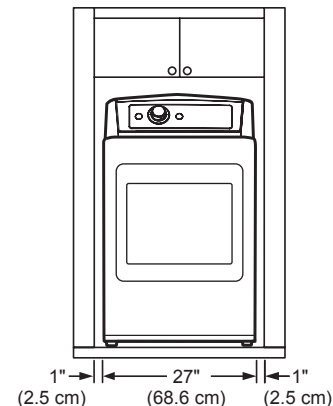
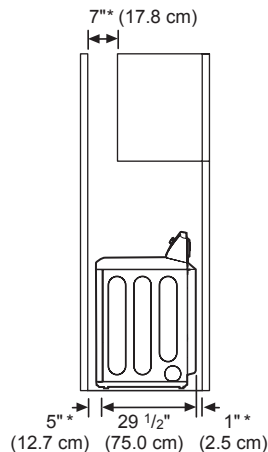
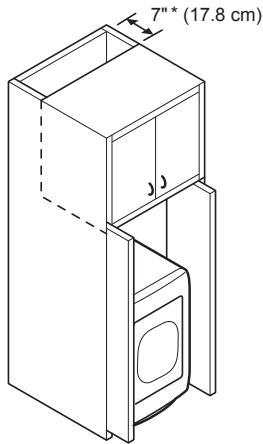

* Required spacing

VENTING THE DRYER

- If connecting to existing ductwork, make sure it is suitable and clean before installing the dryer.
- Venting must conform to local building codes.
- Gas dryers **MUST** exhaust to the outdoors.
- Use only 4-inch (10.2 cm) rigid, semi-rigid or flexible metal ductwork inside the dryer cabinet and for venting outside.
- The exhaust duct must be 4 inches (10.2 cm) in diameter with no obstructions. The exhaust duct should be kept as short as possible. Make sure to clean any old ducts before installing your new dryer.
- Rigid, semi-rigid or flexible metal ducting is recommended for use between the dryer and the wall. All non-rigid metal transition duct must be UL-listed. Use of other materials for transition duct could affect drying time.
- Ductwork is not provided with the dryer. You should obtain the necessary ductwork locally. The vent hood should have hinged dampers to prevent backdraft when the dryer is not in use.
- The total length of flexible metal duct must not exceed 8 ft. (2.4 m).

NOTE:

- Deduct 6 ft. (1.8 m) for each additional elbow. Do not use more than four 90° elbows.

ROUTING AND CONNECTING DUCTWORK

NOTE:

Follow the guidelines below to maximize drying performance and reduce lint buildup and condensation in the ductwork. Ductwork and fittings are **NOT** included and must be purchased separately.

- Use 4-inch (10.2 cm) diameter rigid, semi-rigid or flexible metal ductwork.
- The exhaust duct run should be as short as possible.
- Use as few elbow joints as possible.
- The male end of each section of exhaust duct must point away from the dryer.
- Use duct tape on all duct joints.
- Insulate ductwork that runs through unheated areas in order to reduce condensation and lint buildup on duct surfaces.
- Incorrect or inadequate exhaust systems are not covered by the dryer warranty. Dryer failures or service required because of such exhaust systems will not be covered by the dryer warranty.

DUCTWORK

Wall Cap Type	Number of 90° Elbows	Maximum length of 4-inch diameter rigid metal duct
	0	65 ft. (19.8 m)
	1	55 ft. (16.8 m)
	2	47 ft. (14.3 m)
	3	36 ft. (11.0 m)
	4	28 ft. (8.5 m)
	0	55 ft. (16.8 m)
	1	47 ft. (14.3 m)
	2	41 ft. (12.5 m)
	3	30 ft. (9.1 m)
	4	22 ft. (6.7 m)

CORRECT VENTING

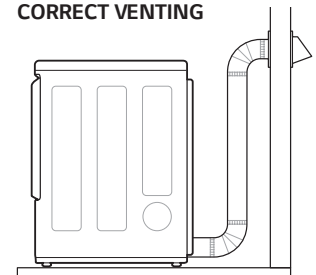

ELECTRIC & GAS CONNECTION LOCATIONS

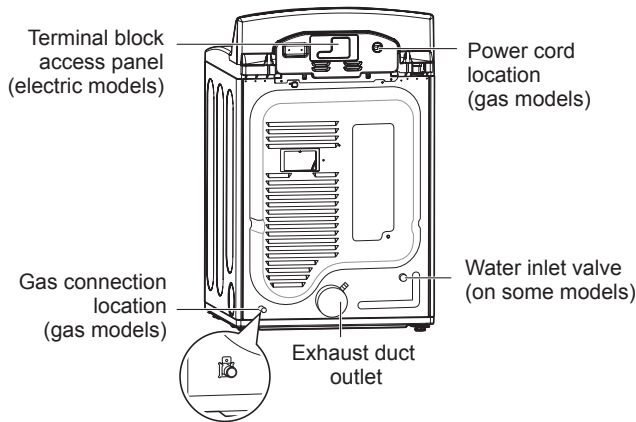

CONNECTING GAS DRYERS

Gas Supply Requirements

- As shipped from the factory, this dryer is configured for use with natural gas (NG). It can be converted for use with propane (LP) gas. Gas pressure must not exceed 8-inch (20.4 cm) water column for NG, or 13-inch (33.1 cm) water column for LP.
- A qualified service or gas company technician must connect the dryer to the gas service.

Electrical Requirements for Gas Models Only

- This dryer must be plugged into a 120-VAC, 60-Hz. grounded outlet protected by a 15-ampere fuse or circuit breaker.
- This dryer is equipped with a three-prong grounding plug for protection against shock hazard and should be plugged directly into a properly grounded three-prong receptacle. Do not cut or remove the grounding prong from this plug.

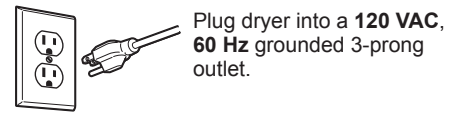

CONNECTING ELECTRIC DRYERS

Electrical Requirements for Electric Models Only

- This dryer must be connected to a grounded metal, permanent wiring system, or an equipment-grounding conductor must be run with the circuit conductors and connected to the equipment-grounding terminal or lead on the dryer.
- The dryer has its own terminal block that must be connected to a separate 240 VAC, 60-Hertz, single-phase circuit, fused at 30 amperes (the circuit must be fused on both sides of the line).
- If the branch circuit to dryer is 15 ft. (4.5 m) or less in length, use UL (Underwriters Laboratories) listed No.-10 AWG wire (copper wire only), or as required by local codes. If over 15 ft. (4.5 m), use UL-listed No.-8 AWG wire (copper wire only), or as required by local codes. Allow sufficient slack in wiring so the dryer can be moved from its normal location when necessary.
- The power cord (pigtail) connection between the wall receptacle and the dryer terminal block IS NOT supplied with the dryer. Type of pigtail and gauge of wire must conform to local codes.

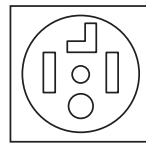

FOUR-WIRE POWER CORD

- A 4-wire connection is required for all mobile and manufactured home installations, as well as all new construction after January 1, 1996.
- A UL-listed strain relief is required.
- Use a 30-amp, 240-volt, 4-wire, UL-listed power cord with #10 AWG-minimum copper conductor and closed loop or forked terminals with upturned ends.

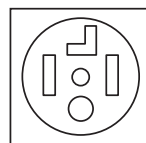

FOUR-WIRE DIRECT WIRE

- A 4-wire connection is required for all mobile and manufactured home installations, as well as all new construction after January 1, 1996.
- A UL-listed strain relief is required.
- Use UL-listed 4-wire #10 AWG minimum copper conductor cable. Allow at least 5 ft. (1.5 m) of wire to allow for removal and reinstallation of the dryer.